

JBL SCL-8

2-Way 5.25-inch (130mm) In-Ceiling Loudspeaker

JBL

S Y N T H E S I S



Highlights:

- 2-way in-ceiling loudspeaker system designed for off-axis listening as height, in-ceiling LCR and surround channels
- Features 1-inch 2410H-2 compression driver tweeter mated to a JBL patented offset High-Definition Imaging (HDI™) horn assembly, angled toward listening area
- Complemented with a 5.25-inch (130mm) advanced aluminum matrix cone, cast frame woofer with waveguide baffle, angled to match HDI horn
- Patented Cat Claw mounting mechanism for faster installations
- Gold plated, spring-loaded binding posts
- Comes with paintable zero-bezel, magnetically attached round and square grilles
- Compatible with CB8 pre-construction bracket

General Specifications:

- ▶ Type: 2-way in-ceiling loudspeaker
- ▶ Low Frequency Driver: 5.25" (130mm) advanced Aluminum Matrix cone cast-frame woofer (JW130AI-4)
- ▶ High Frequency Driver: 1" (25mm) 2410H-2 Teonex® annular ring-diaphragm compression driver
- ▶ Recommended Amplifier Power: 25 – 100W RMS
- ▶ Impedance: 4 Ohm
- ▶ Loudspeaker Sensitivity: 85dB/2.83V/1m
- ▶ Frequency Response: 55Hz – 30kHz (-6dB on-axis), 2pi anechoic
- ▶ Crossover Frequency: 1.8kHz
- ▶ High Frequency Coverage Angle (-6dB): 60° Vertical (Up: 30°, Down: 30°, from 45° Vertical Center line), 120° Horizontal, from 2kHz to 10kHz
- ▶ Enclosure Type: Open back
- ▶ Controls: Boundary Proximity Control
- ▶ Grille Dimensions: Round: 10.77" (273mm) Diameter; Square: 10.77" (273mm) x 10.77" (273mm)
- ▶ Product Dimensions (with grille): 10.77" H x 10.77" W x 4.73" D (273mm x 273mm x 120mm)
- ▶ Cut-out Diameter: 9.49" (241mm)
- ▶ Accessory Rough-in Bracket: CB8
- ▶ Mounting Depth: 4.54" (115mm)
- ▶ Input Type: Gold-plated spring-loaded binding posts
- ▶ Product Weight: 7.8 lb. (3.5kg)
- ▶ Shipping Weight: 10.6 lb. (4.8kg)
- ▶ Shipping Units of Measure: Each
- ▶ Warranty: 5 Years

JBL SCL-8

2-Way 5.25-inch (130mm) In-Ceiling Loudspeaker

JBL

SYNTHESIS

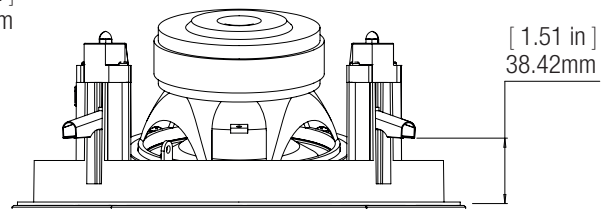
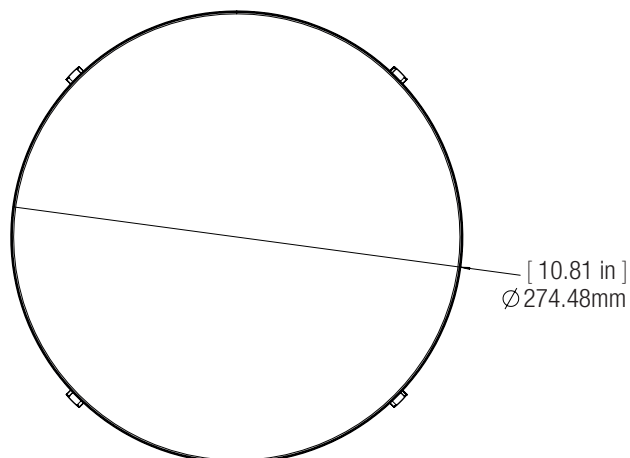
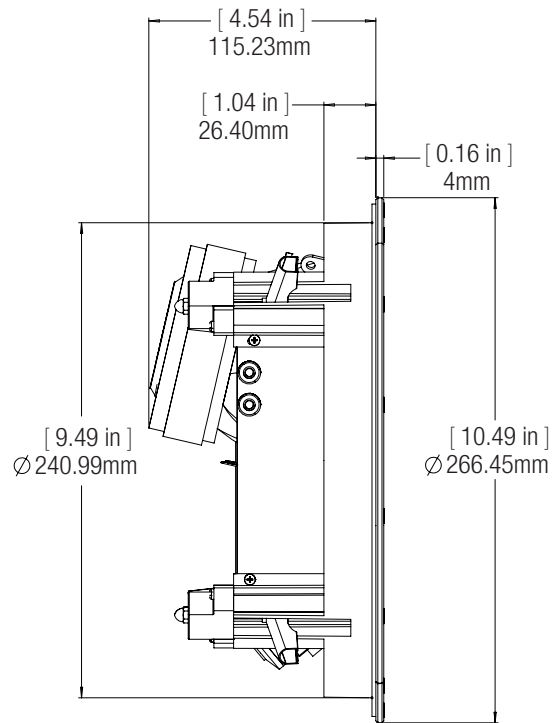
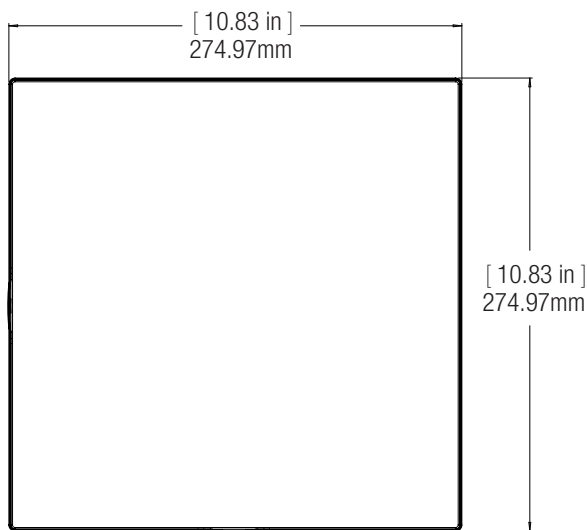
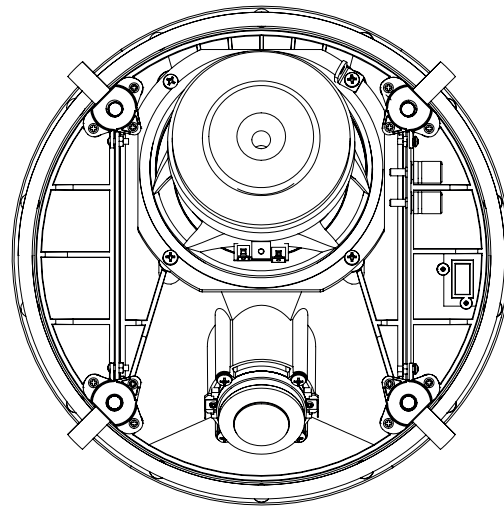
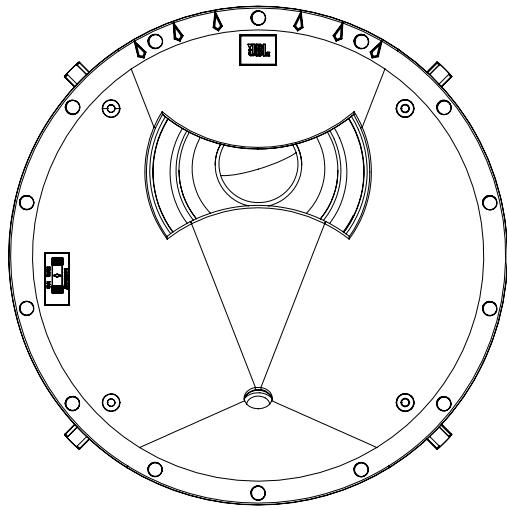

HARMAN International Industries, Incorporated
8500 Balboa Boulevard, Northridge, CA 91329 USA
www.jblsynthesis.com

© 2021 HARMAN International Industries, Incorporated. All rights reserved. JBL and JBL Synthesis are trademarks of HARMAN International Industries, Incorporated, registered in the United States and/or other countries. Features, specifications and appearance are subject to change without notice.