

SCL-5 Cut Out Template

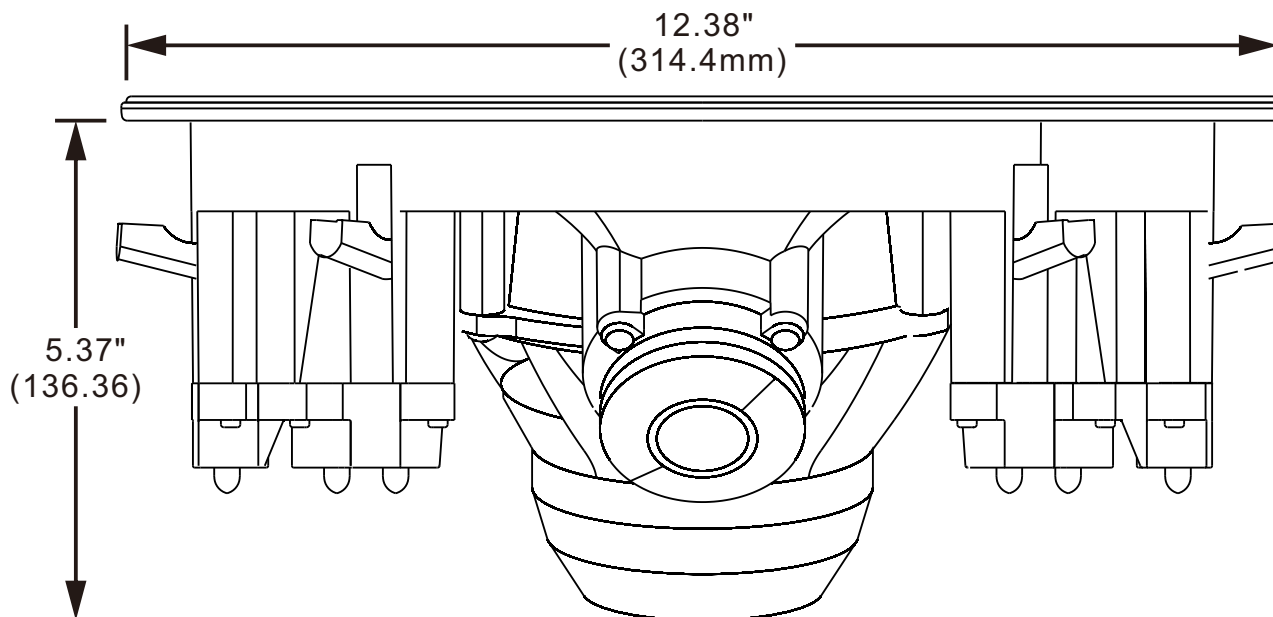

Note: 1" (25.4mm) must be clear behind the drywall to provide adequate room for the mounts to engage.

Ø11.22"
(285mm)